

DVD

DVD

Kawas

PVS297

Twin DVD Mobile

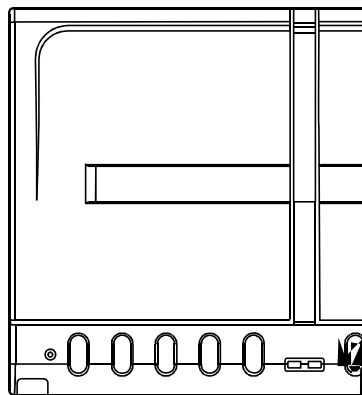

OFFICIAL • LICENSED • PRODUCT

OWNER'S M

SAFETY PRECAUTIONS

CAUTION



The lightning flash with an arrowhead symbol within the equilateral triangle, is intended to alert the user to the presence of uninsulated "dangerous voltage" within the product's enclosure that may be of sufficient magnitude to cause an electric shock.



The exclamation point within the equilateral triangle is intended to alert the user to the presence of important operating and maintenance (servicing) instructions in this owner manual.



This product contains a low power laser device.

The symbol for Class II (Double Insulation)

WARNING: TO REDUCE THE RISK OF ELECTRIC SHOCK, DO NOT REMOVE COVER (OR BACK). NO USER-SERVICEABLE PARTS INSIDE. REFER SERVICING TO QUALIFIED SERVICE PERSONNEL.

CAUTION
INVISIBLE LASER
RADIATION WHEN OPEN
AND INTERLOCKS
DEFEATED.

On Placement

- Do not use the unit in places which are extremely hot, cold, dusty, or humid.
- Do not restrict the air flow of the unit by placing it in a place with poor air flow, by covering it with a cloth, or by placing it on carpeting.

FCC Information

This device complies with Part 15 of FCC Rules.

Operation is subject to the following two conditions:

- (1) This device may not cause harmful interference, and
- (2) This device must accept any interference received, including interference that may cause undesirable operation.

On Safety

- When connecting or disconnecting the AC cord, grip the plug and not the cord itself. Pulling the cord may damage it and create a hazard.
- When you are not going to use the unit for a long period of time, disconnect the AC power cord.

On Condensation

- When left in a heated room where it is warm and damp, water droplets or condensation may form inside the unit.
- When there is condensation inside the unit, the unit may not function normally. Let the unit stand for 1 to 2 hours before turning the power on. Gradually heat the room up and dry the unit before use.

WARNING:

- Should any trouble occur, disconnect the AC power cord and refer servicing to a qualified technician.

Notes on Copyright

It is forbidden by law to copy, broadcast, show, broadcast on cable, play in public or rent copyrighted material without permission.

Apparatus Claims of U.S. Patent Nos. 4,631,603; 4,577,216; 4,819,098 and 4,907,093 licensed for limited viewing uses only.

DVD video discs are copy protected, and any recordings made from these discs will be distorted. This product includes digital rights management technology that is protected by method claims of certain U.S. patents and other

patents owned by Macrovision Corporation and other rights owners. Use of this copyright

technology is limited to the uses specified in the Macrovision Corporation, and is intended for home and other limited

use only. Reverse engineering or disassembly of this product is prohibited. © 2004 Macrovision Corporation. Reverse engineering or disassembly

IMPORTANT SAFETY INSTRUCTIONS

- 1. Read Instructions** - All the safety and operating instructions should be read before the appliance is operated.
- 2. Retain Instructions** - The safety and operating instructions should be retained for future reference.
- 3. Heed Warnings** - All warnings on the appliance and in the operating instructions should be adhered to.
- 4. Follow Instructions** - All operating and use instructions should be followed.
- 5. Water and Moisture** - The appliance should not be used near water - for example, near a bathtub, washbowl, kitchen sink, laundry tub, in a wet basement, or near a swimming pool, and the like.
- 6. Carts and Stands** - The appliance should be used only with a cart or stand that is recommended by the manufacturer.
- 6A.** An appliance and cart combination should be moved with care. Quick stops, excessive force, and uneven surfaces may cause the appliance and cart combination to overturn.
- 7. Wall or Ceiling Mounting** - The appliance should be mounted to a wall or ceiling only as recommended by the manufacturer.
- 8. Ventilation** - The appliance should be situated so that its location or position does not interfere with its proper ventilation. For example, the appliance should not be situated on a bed, sofa, rug, or similar surface that may block the ventilation openings; or, placed in a built-in installation, such as a book case or cabinet, that may impede the flow of air through the ventilation openings.
- 9. Heat** - The appliance should be situated away from heat sources such as radiators, heat registers, stoves, or other appliances (including amplifiers) that produce heat.
- 10. Power Sources** - The appliance should be connected to a power supply only of the type described in the operating instructions or as marked on the appliance.
- 11. Grounding or Polarization** - Precautions should be taken so that the grounding or polarization means of an appliance are not defeated.
- 12. Power-Cord Protection** - Power-supply cords should be routed so that they are not likely to be walked on or pinched by items placed upon or against them, paying particular attention to cords at plugs, convenience receptacles, and the point where they exit from the appliance.
- 13. Cleaning** - The appliance should be cleaned only as recommended by the manufacturer.
- 14. Nonuse Periods** - The power cord of the appliance should be unplugged from the outlet when left unused for a long period of time.
- 15. Object and Liquid Entry** - Care should be taken so that objects do not fall, and liquids are not spilled into the enclosure through openings.
- 16. Damage Requiring Service** - The appliance should be serviced by qualified service personnel when:
 - A. The power-supply cord or the plug has been damaged; or
 - B. Objects have fallen, or liquid has been spilled into the appliance; or
 - C. The appliance has been exposed to rain; or
 - D. The appliance does not appear to operate normally or exhibits a marked change in performance; or
 - E. The appliance has been dropped, or the enclosure damaged.
- 17. Servicing** - The user should not attempt to service the appliance beyond that described in the operating instructions. All other servicing should be referred to qualified service personnel.



TABLE OF CONTENTS

Safety Precautions	1	Repeat Playback	20
Important Safety Instructions	2	Repeating a title/chapter (DVD)	20
Table of Contents	3	Repeating a single track/whole disc (CD)	20
Disc Formats	4	Repeating a specific section (DVD)	20
Accessories	5	Playing MP3/Digital Picture Files Disc ..	21
Remote Control	5	Playing a MP3/Digital Picture files Disc	21
Control Reference Guide	6-8	Customizing the Function Settings	22-23
Screen Viewing Angle Adjustment	9	LANGUAGE setting	22
Power Supply	9	VIDEO setting	22
Using the Car plug adaptor	9	AUDIO setting	23
Using the AC adaptor	9	RATING setting	23
Connections	10-13	Language Code List	24
Connecting the Monitors	10-11	Maintenance	25
Using this Unit with Other Equipment	12-13	Cleaning Disc	25
Using Headphones/Earphones	13	Cleaning the Unit	25
Installation Guide	14	Important Note	25
Unit Operation	14	Trouble Shooting Guide	26
Sound System	14		
Playing a Disc	15-16		
Playing a Disc on DISC A/B	15		
Pausing playback (still mode)	15		
Stopping playback	15		
To skip to a different track	15		
Fast Foward/Fast Reverse	15		
Skip (Forward/Reverse)	16		
Audio selection	16		
Angle selection	16		
Subtitle selection	16		
Special Functions	17-18		
Display function	17		
GOTO function	17		
Locating a specific title	17		
Locating a specific chapter/track	18		
Locating a specific time	18		
CD/DVD Programmable Memory	19		
DVD programmable memory	19		
CD programmable memory	19		

DISC FORMATS

The unit can playback.



DVDs
[8cm/12cm disc]



Audio CDs
[8cm/12cm disc]

CD-R CD-RW
Compatible

Region Management Information

Region Management Information: This unit is designed and manufactured to respond to the Region Management Information that is encoded on DVD discs. If the Region number printed on the DVD disc does not correspond to the Region number of this unit, this unit cannot play that disc.



The region number of this unit is 1.

Disc Function or Operation that is Not Available

When the  symbol appears on the screen, it indicates that the function or operation attempted is not available at that time. This occurs because the DVD disc manufacturer determines the specific functions. Certain functions may not be available on some discs. Be sure to read the documentation provided with the DVD.

Icons Used on DVDs

Sample Icons

	Language selections for audio
	Language selections for subtitles
	Screen aspect ratio
	Multiple camera angles
	Region code indicator

Notes:

- This Unit supports 2-channel (L/R) audio and 5.1ch (Multi-channel) MPEG Audio 1/2 (only when the DIGITAL AUDIO OUT coaxial jack is used for connection). It does not support 7.1 channel MPEG Audio Version 2.0.
- When playing back a CD-G (Graphics) or CD EXTRA disc, the audio portion will be played, but the graphic images will not be shown.

Title, Chapter and Tracks

DVDs are divided into “titles” and “chapters”. If the disc has more than one movie on it, each movie would be a separate “title”. “Chapters” are sections of titles.

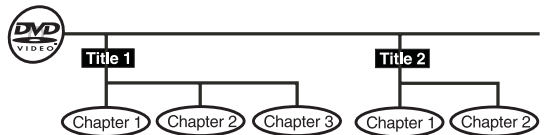

Audio CDs are divided into “tracks”. A “track” is usually one song on an Audio CD.



Note :

- Numbers identify each title, chapter, and track on a disc. Most discs have these numbers recorded on them, but some do not.

Notes on Unauthorized Discs

You may not be able to play back some DVD discs on this unit if they were purchased from outside your geographic area or made for business purposes.

ACCESSORIES

Please check and identify the supplied accessories.

Use item number indicated in parentheses when ordering replacement parts.

To order accessories contact 1-800-252-6123 or visit (<http://www.18002526123.com>)

- Remote control (Disc A / with battery) x 1
- Remote control (Disc B / with battery) x 1
- AC adaptor x 1
- AC power cord x 1
- 12V car plug adaptor x 1
- Strap x 2
- Carrying bag x 1

REMOTE CONTROL

Using the Remote Control

- Point the Remote Control at the REMOTE SENSOR located on the unit.
- When there is a strong ambient light source, the performance of the infrared REMOTE SENSOR may be degraded causing unreliable operation.
- The recommended effective distance for remote operation is about 16 feet (5 meters).

Remove the protective plastic tab before operating the Remote Control.

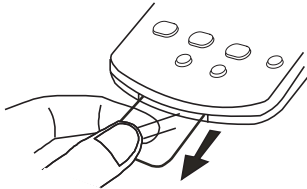

TO CHANGE REMOTE BATTERY

1. Open the battery door.

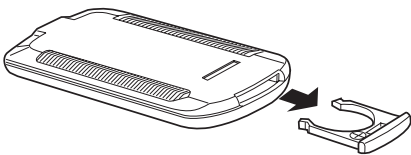

2. Insert one CR2025 (3V) size battery.

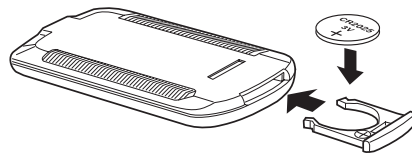

BATTERY REPLACEMENT

When battery becomes weak, the operating distance of the Remote Control will be greatly reduced and you will need to replace the battery.

NOTE:

- If the Remote Control is not to be used for a long time, remove the battery to avoid corrosion damage caused by battery leakage.



WARNING: Do not dispose of batteries in a fire, batteries may explode or leak.

CONTROL REFERENCE GUIDE

Remote Control for Disc A/B

1) TV MODE button

In stop mode, select whether to output the video signal. TV shows "AUTO" means output signal depends on DVD (either NTSC or PAL). TV shows "PAL" or "NTSC" which means output signal fixed to PAL or NTSC.

2) ■ STOP button

Stop playing a disc.

▶ **PLAY button**

CONTROL REFERENCE GUIDE

Unit

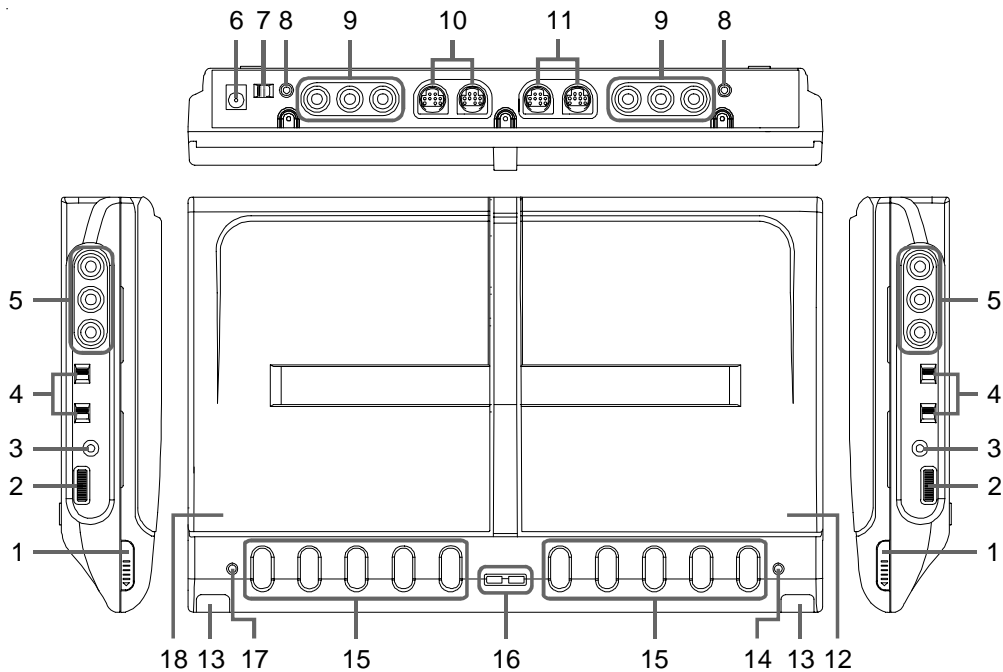

- 1) **Open button**
Open the disc door.
- 2) **VOLUME control**
Adjust the volume.
- 3) **Headphone jack**
- 4) **AV IN / DVD switches**
- 5) **AUDIO / VIDEO IN jacks**
- 6) **DC IN 12V jack**
- 7) **POWER ON / STANDBY switch**
- 8) **DIGITAL OUT jack**
- 9) **AUDIO / VIDEO OUT jacks**
- 10) **MONITOR 1 & 2 ports (output)**
- 11) **MONITOR 3 & 4 ports (output)**
- 12) **Disc Door B**
Close by pushing the disc door.
- 13) **Remote sensor**
Receives the remote control unit signals.
- 14) **Operation Indicator (DISC B)**
The indicator will illuminate when the unit is playing the disc.
- 15) **◀◀ PREV button**
Press ◀◀ **PREV** button to go back to previous chapters/tracks. Press and hold ◀◀ **PREV** button to begin fast scan. Four speeds are available.
▶▶ NEXT button
Press ▶▶ **NEXT** button to advance to chapters / tracks. Press and hold ▶▶ **NEXT** button to begin fast scan. Four speeds are available.
⏸ PAUSE button
Press to pause playback of disc.
Each time you press the PAUSE button the picture advances one frame. Press the PLAY ▶ button to resume playback.
■ STOP button
Stop playing a disc.
▶ PLAY button
Press to start or resume playback a disc.
- 16) **POWER ON / STANDBY indicator**
The indicator will illuminate when the unit is in ON / Standby mode.
- 17) **Operation Indicator (DISC A)**
The indicator will illuminate when the unit is playing the disc.
- 18) **Disc Door A**
Close by pushing the disc door.

CONTROL REFERENCE GUIDE

Monitor

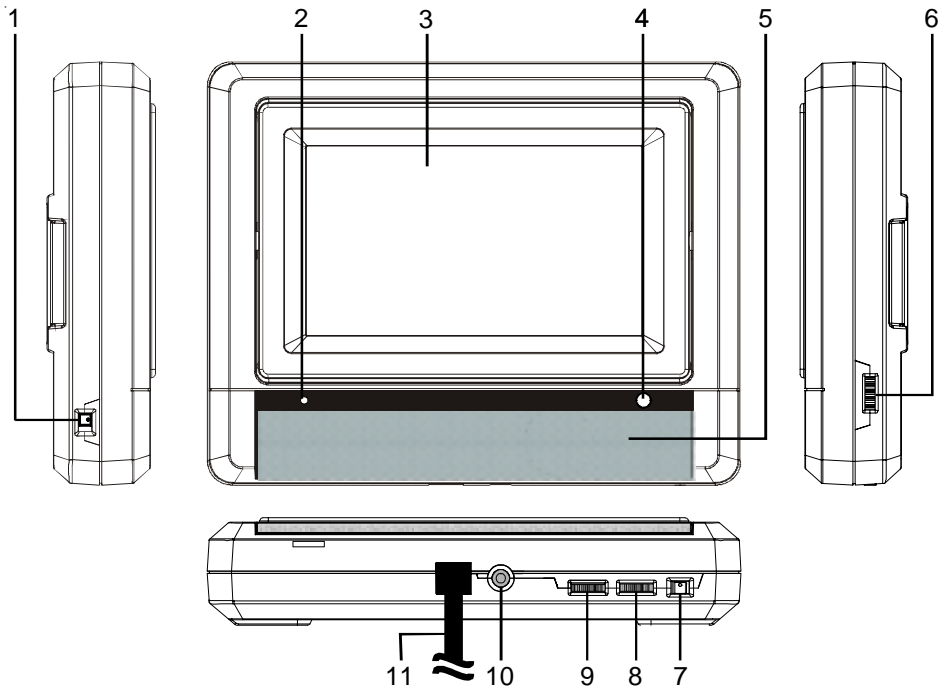

- | | |
|------------------------------------------------------------------------------------------------------------------------------------------------------------------------------------------------------------------------------------------------------------------------------------------------------|-----------------------------------------------------------------------------------------------------------------------------------------------------------------------------------------------------------------------------------------------------------------------------------------------------------------------------------------------------|
| <p>1) MONITOR ON / OFF switch</p> <p>2) STANDBY indicator
The LED will illuminate when the monitor is in standby mode.</p> <p>3) Screen</p> <p>4) Remote sensor
Receives the remote control signal.</p> <p>5) Speaker</p> <p>6) VOLUME control</p> | <p>7) SCREEN switch
WIDE: Wide Screen
NORMAL: Pan screen</p> <p>8) COLOR control
Adjust for color intensity.</p> <p>9) BRIGHTNESS control
Adjust the lightness or darkness of the color.</p> <p>10) Headphone / Earphone jack</p> <p>11) Built-in EZ CABLE CONNECT TO MAIN UNIT port (Input)</p> |
|------------------------------------------------------------------------------------------------------------------------------------------------------------------------------------------------------------------------------------------------------------------------------------------------------|-----------------------------------------------------------------------------------------------------------------------------------------------------------------------------------------------------------------------------------------------------------------------------------------------------------------------------------------------------|

Installation of Monitors

- Use supplied mounting straps to install the monitors onto the seat back in a car.

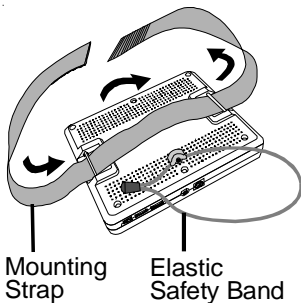

- 1) Loop the safety band around the headrest.

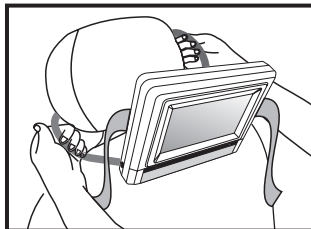

- 2) Tightly wrap the mounting strap around the headrest.

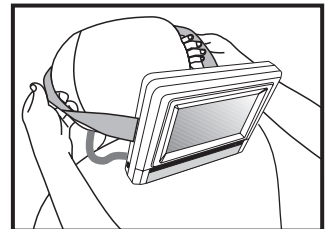

SAFETY WARNING!

- This unit should never be used by the vehicle's driver or left unsecured in the vehicle while driving.
- If this unit is being used in your vehicle, be sure that it is secured or held safely, and does not obstruct any safety device, including air bags or seat belts.
- All passengers should wear seat belts when using this unit in a moving vehicle.
- If in doubt, please contact your vehicle manufacturer for further advice.

SCREENVIEWING ANGLE ADJUSTMENT

The Monitor is designed to allow users to have a comfortable viewing angle. The viewing angle can be adjusted +/- 12°.

- Gently push the top or bottom of the screen frame to adjust the viewing angle.

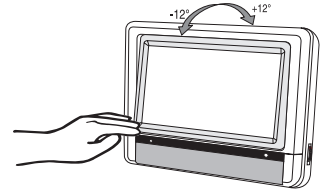

Caution:

- Do not force the screen frame over its maximum viewing angle or damage to the unit could result.

POWER SUPPLY

A. Using the car plug adaptor

The included 12V car plug adaptor is designed for use with vehicles that have a 12V, negative ground electrical system.



Cautions:

- Use this unit only with the included 12V car plug adaptor. Use with other car adaptors could damage the system.
- The included 12V car plug adaptor is for use with this unit only. Do not use it with other equipment.
- Do not operate the unit or watch videos while driving a vehicle.
- Make sure the unit is secured correctly to prevent it from falling inside the vehicle in the event of an accident.
- When the inside of the 12V car socket is dirty with ashes or dust, the plug section may become hot due to poor contact. Be sure to clean the 12V car socket before use.
- After use, disconnect the 12V car plug adaptor from both the unit and 12V car socket.
- Check your local traffic laws for rules governing the use of video devices in vehicles.

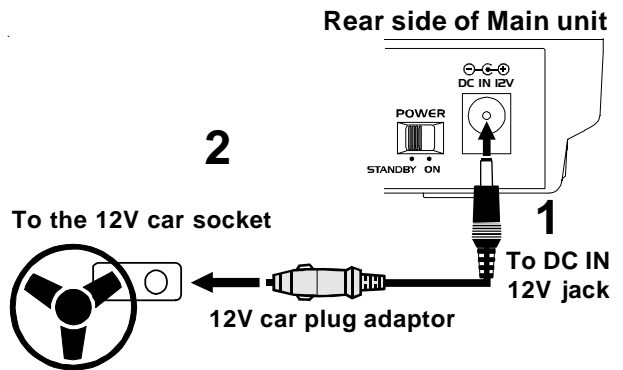

B. Using the AC adaptor

This unit can be powered by connecting the included AC adaptor to support **TWO** monitors.

Before you buy an AC Adaptor, please note, the only AC adaptor suitable for this unit is DC 12V 3.0A, with plus center polarity ⊖ ⊕ ⊕ . Please check voltage & current (A) carefully.

Attention:

When 4 monitors are to be used, please visit our website www.18002526123.com to buy a suitable AC adaptor to support 4 monitors.

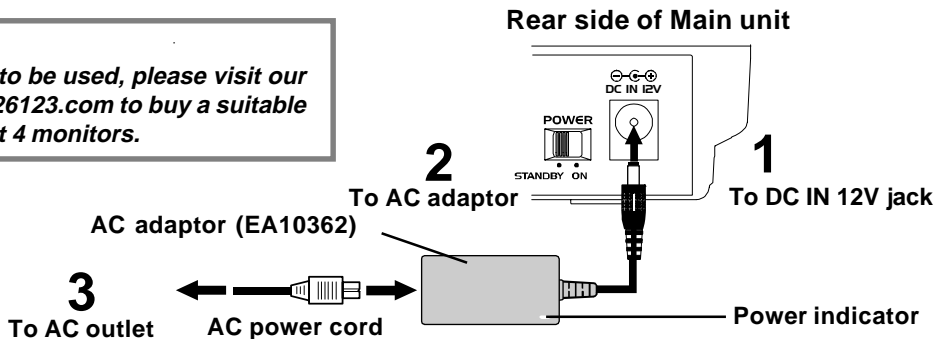

Cautions:

- Use of an incorrect type AC adaptor will damage the unit.
- Turn off the unit before unplugging the AC adaptor from the unit so as to avoid the unit being damaged.
- **To prevent electrical shock, match wide blade of plug to wide slot and fully insert.**
- When the unit is not going to be used for long time, disconnect the AC power supply cord from the AC outlet.

CONNECTIONS

Connecting the Monitors

Connecting 4 monitors to play the same movie in your car

- Use 12V car plug to connect the main unit.
- Connect the built-in EZ View cable of 4 monitors to the rear side of main unit.
- Use Audio/Video cable to connect from "AV OUT" of DISC B to "AV IN" of DISC A.
- Turn on the main unit, slide the AV IN / DVD switch to "AV IN" on DISC A.
- Then turn on the 4 monitors.
- Play your selected disc on DISC B.
- You can see same movie through 4 monitors in different seats of your car.

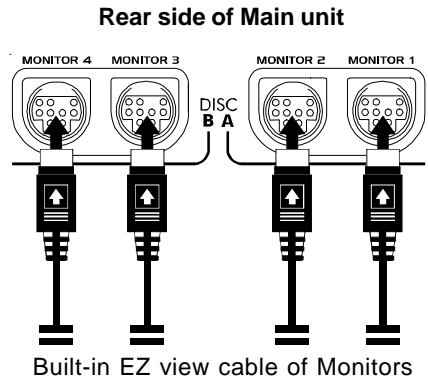
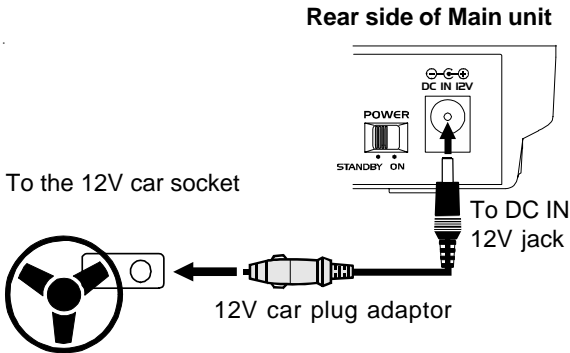

Rear side of Main unit (DISC B)

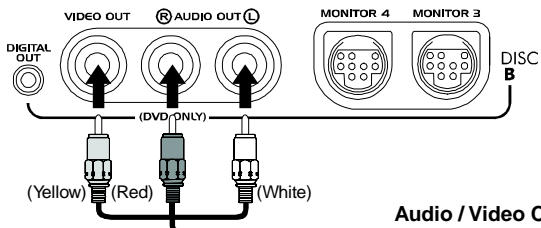

Left side of Main unit (DISC A)

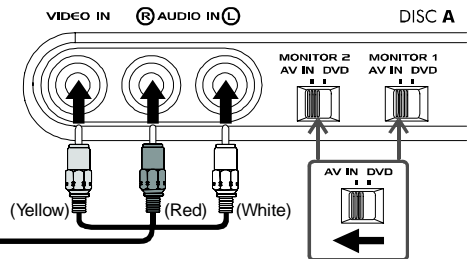

Note:

- If you play **ONE** movie for **TWO** monitors, play your selected disc on DISC A OR B, then connect the monitors to MONITOR 1 and 2 for DISC A or MONITOR 3 or 4 for DISC B.

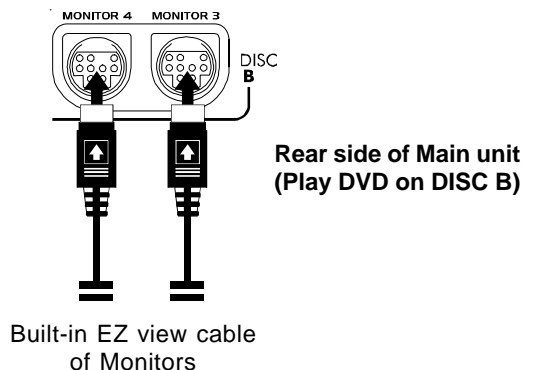
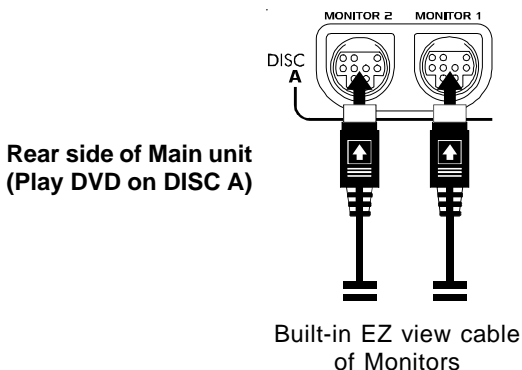

CONNECTIONS

Connecting 4 monitors to play the two different movies in

- Use 12V car plug to connect the main unit.
- Connect the the built-in EZ View cable of 4 monitors to the rear side of m [i.e. DISC A for Monitor 1 and 2, DISC B for Monitor 3 and 4.]
- Turn on the main unit, slide the AV IN / DVD switch to "DVD" on DISC A a
- Play the two different discs on DISC A and B.
- You can see the two different movies through 4 monitors in different seat

Rear side of Main unit

To DC IN
12V jack

12V car plug adaptor

To the 12V car socket

FF

CONNECTIONS

Using this Unit with Other Equipment

A. Connecting Game Systems / Video Equipment

- You can connect Game Systems or other Video Equipment for playback through the monitors.

Watching Video Equipment

- Turn on the unit, slide the **AV IN / DVD** switch to "AV IN".
- Turn on the video equipment and follow the instructions provided with it to playback.

Note:

If you have a mono VCR, the volume level from the speakers will be low.

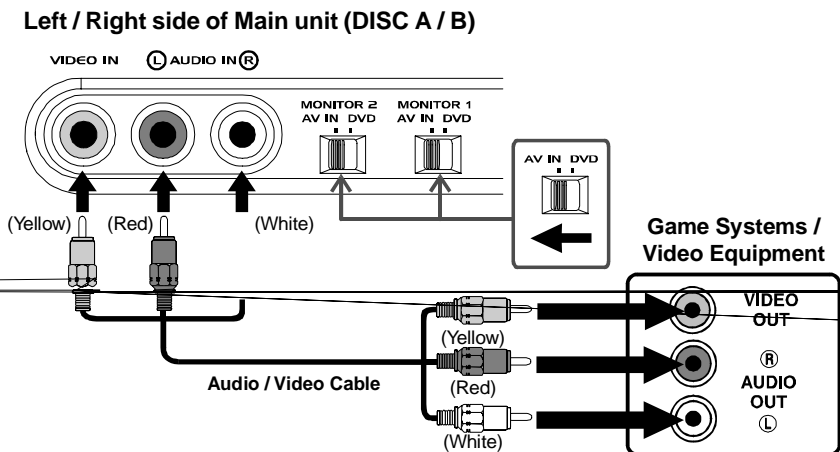

B. Connecting the unit to a TV

- This DVD Player can be used with a TV that has A/V inputs. If your TV does not have A/V inputs, you can purchase an RF modulator (sold separately) to connect the DVD player.

Watching a DVD on your TV

- Turn on the unit, slide the **AV IN / DVD** switch to "DVD".
- Turn on the TV and follow the instructions provided with it to play the DVD.

Note:

Make sure you use the correct Audio/Video cable.

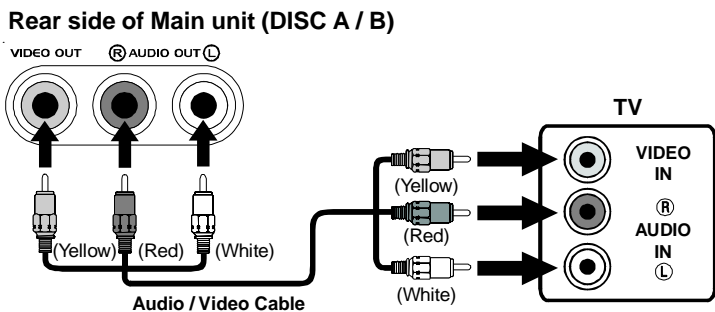

C. Connecting a Stereo Receiver or Amplifier

Analog connection

Rear side of Main unit (DISC A / B)

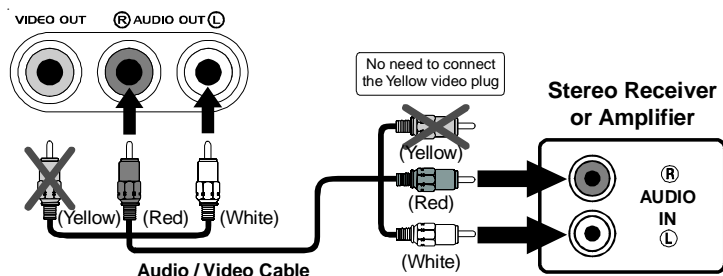

CONNECTIONS

Connecting to a Surround Sound System

Listening to another audio equipment

1. Turn on the Unit.
2. Turn on your audio equipment and follow the instructions provided with it to select the AUDIO IN or DIGITAL IN function.

Notes:

- Make sure to use the correct Audio/Video cable, connecting the plugs incorrectly may cause a weak signal.
- If you have a stereo VCR, make sure you set it to stereo mode.
- Due to copyright protection, DVD movies cannot be copied. If you copy a DVD movie onto a videotape, the resulting copy will be unclear, with poor sound quality. This is NOT caused by a defective DVD system.

Rear side of Main unit (DISC A / B)

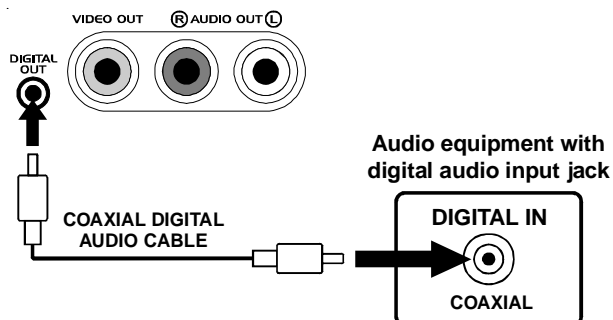

Using Headphones/Earphones

- Turn down the volume before connecting the Headphones / Earphones. Slowly raise the volume with the headphones / earphones on until you reach your desired volume.
- When headphones / earphones are connected to the monitors, the speakers will be disabled.



Caution:

- Listening to audio at an excessive volume can permanently damage your hearing.

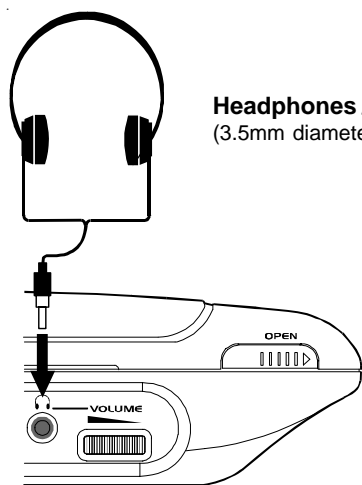

Headphones / Earphones
(3.5mm diameter plug)

Right / Left side of unit for DISC A / B

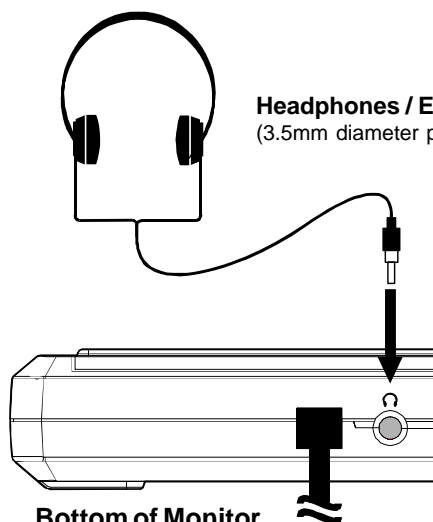

Headphones / Earphones
(3.5mm diameter plug)

Bottom of Monitor

Note:

When headphones / earphones are connected to the main unit, the speakers will be disabled.

This owner's manual explains the basic instructions of this unit. Some DVD discs are produced in a manner that allows specific or limited operation during playback. Such as, the unit may not respond to all operating commands. This is not a defect in the unit. Refer to the instruction notes of discs.

“” may appear on the screen during operation. A “” means that the desired operation is not permitted by the unit or disc.

Playing a Disc on DISC A / B

1. Slide the **POWER ON/STANDBY** switch on the rear side of unit into ON mode.

See **CUSTOMIZING THE FUNCTION SETTINGS** before proceeding to step 2.

2. Hold the top and slide the **OPEN** switch to open the disc door A / B.

3. Hold the disc by its sides and carefully fit onto the central support of compartment with the label side facing forward until you hear a “click”.

4. Close the disc door A / B.

It takes a short while for your unit to load the disc. After loading, for some discs, the unit will automatically start playback of the disc. (The indicator of DISC A / B on left / right side lights up.)

5. Press the **▶ PLAY** button.

Pausing playback (still mode)

Press the **⏸ PAUSE** button. To resume normal playback, press the **▶ PLAY** button.

Each time you press the **⏸ PAUSE** button, the picture advances one frame.

Stopping playback

Press the **■ STOP** button at the location where you want to interrupt playback. To resume playback at the position where the disc was stopped, press the **▶ PLAY** button.

If you press the **■ STOP** button twice, the unit's memory will be cleared and pressing the **▶ PLAY** button will reset the disc to the beginning.

To skip to a different track

- Press the **⏮ PREV** button repeatedly to skip to the start of the current or previous track.
- Press the **⏭ NEXT** button to skip to the next track.
- For audio CD disc, use the number buttons (remote control only) to jump straight to that track number.

Fast Forward / Fast Reverse

1. Press the **SEARCH ⏭** or **⏮ SEARCH** button when a disc is playing.

• The disc begins fast scan at x2 speed.

• Four speeds are available. Each time **SEARCH ⏭** or **⏮ SEARCH** button is pressed, the speed of fast scan changes in the following sequence:

▶ x 2 → ▶ x 4 → ▶ x 8 → ▶ x 20



The speed of fast scan



Note:

You also can press and hold **⏮ / ⏭ (SKIP)** buttons repeatedly to select different fast scan speeds.

2. Press the **▶ PLAY** button when you reach the desired point to resume playback at normal speed.

SKIP (Forward / Reverse)

While you are playing a disc, press the **▶▶ NEXT** button to move to the beginning of the next chapter or track. Press the **◀◀ PREV** button to move to the previous chapter or track and automatically start playing it.

Audio selection

On some discs, the sound is recorded in two or more formats. Follow the directions below to select the type of playback.

1. While a disc is playing, press the **AUDIO** button to show the current audio format number.
2. Press the **AUDIO** button repeatedly to select the desired audio format.



Notes:

- If only one audio format is recorded, the number does not change.
- About two seconds later, playback continues in the new audio format.

Subtitle selection

1. While a DVD is playing, press the **SUBTITLE / RETURN** button to display the current language setting, as shown in the example below.
2. Press the **SUBTITLE / RETURN** button repeatedly to select the desired subtitle language.



Notes :

- If only one language is recorded, the language does not change.
- About two seconds later, playback continues with the new subtitle you selected.
- The number of languages recorded differ depending on the disc.
- If no button is pressed within a few seconds, playback continues without changing the current subtitle.
- This function can only be used for discs on which subtitles have been recorded in multiple languages.
- On some DVDs, subtitles are activated from the main menu of the DVD. Press the **MENU** button to activate the main menu.

Angle selection

Some DVDs contain scenes which have been shot from a number of different angles. For these discs, the same scene can be viewed from each of these different angles.

1. While you are playing a DVD with different angles recorded, press the **ANGLE** button to view the number of the current angles available.
2. Press the **ANGLE** button repeatedly to change the scene to the next angle in those recorded.
 - About two seconds later, playback continues from the new angle you selected.
 - If no button is pressed within 10 seconds, playback continues without changing the current angle.



Sequence of angle shots (Example)

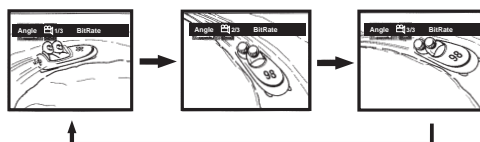

Notes:

- This function can only be used for discs on which scenes shot from multiple angles have been recorded.
- If only one angle is recorded, “ 1/1 ” is displayed.

DISPLAY function

Using DISPLAY, you can check and change the current settings of the following items: ANGLE, AUDIO and SUBTITLE.

- While the disc is playing, press the **DISPLAY** button to display the screen shown below.
 - Elapsed time:** Elapsed time from the beginning of the chapter which is currently playing.
 - Remaining time:** Remaining time of the title which is currently playing.

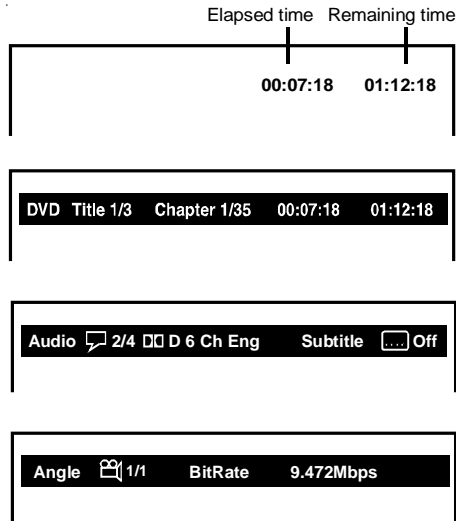

GOTO function

This function allows you to skip directly to any part of the disc while a disc is playing. Press ◀ or ▶ button to highlight time.



Note:

- After settings, press the **DISPLAY** button again to return to the normal screen.

Locating a specific title

If a DVD disc contains title numbers, you can locate a specific title by directly selecting a title number.

1. In stop mode, press the **GOTO** button.
2. Press ◀ or ▶ button to highlight a specific field and press the corresponding number button(s) for the title you want.
3. Press the **ENTER** button to confirm. The Unit will start playback about 3 seconds later.



Locating a specific chapter / track

If you know the chapter / track number you want to play, you can locate a specific chapter / track by directly selecting a chapter / track number.

1. Press the **GOTO** button to search your desired chapter / track.
2. Press ◀ or ▶ button to highlight a chapter / track and press the corresponding number button(s) for the chapter you want.
3. Press the **ENTER** button to confirm. The Unit will start playback about 3 seconds later.

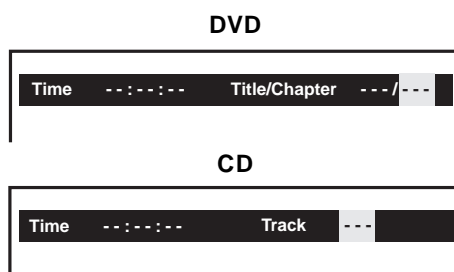
**Locating a specific time**

You can move to a specific location by entering its corresponding time (hours, minutes, seconds).

1. Press the **GOTO** button.
2. Press ◀ or ▶ button to highlight time.
3. Press the corresponding number buttons for the setting point you want.
4. Press the **ENTER** button to confirm. The Unit will start playback about 3 seconds later.

Notes:

- Some discs may not respond to this process.
- Some scenes may not be located as precisely as you specified.
- This method for accessing specific locations is available only within the current title of the DVD disc.

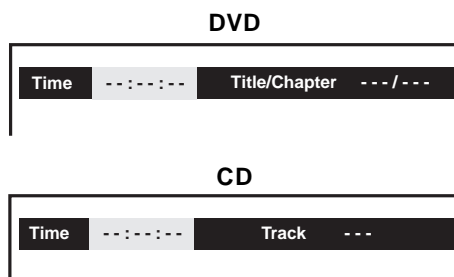

CD/DVD PROGRAMMABLE MEMORY

Program

The two programmed playback

memory

provided by this Unit are title programmed playback and chapter

Title /

1. Press
2. Enter in
3. Use
4. Re
5. Pr

rogrammed playback

button while the disc is stopped. Press the **STOP** button in **STOP**. Use **◀** or **▶** to move the highlight to chapter and enter the chapter numbers to move to the position to start the programmed playback.

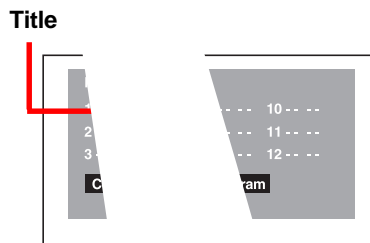

Press the **STOP** button twice, the programmed playback actions will be cleared.

Program

while the disc is stopped. Press the **STOP** button.

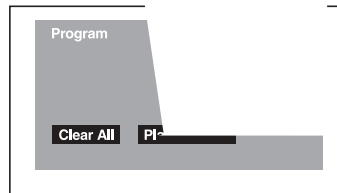

3. Use **◀**, **▶**, **▲** or **▼**
4. Repeat steps 2 to 3
5. Press the **▶ PLAY** but

field. Press the **▶ PLAY** button to start the programmed playback.

You can play a specific title or chapter repeatedly.
(Title repeat, chapter repeat, A-B repeat)

Repeating a chapter

You can play the same chapter repeatedly.

1. While the disc is playing, press the **REPEAT DISC** button until the "Repeat Chapter" indicator displays on the screen. The current chapter is played repeatedly.

Repeat Chapter

Repeating a title

You can play the same title repeatedly.

2. While the disc is playing, press the **REPEAT DISC** button until the "Repeat Title" indicator displays on the screen. The current title is played repeatedly.

Repeat Title

To resume normal playback

3. While the disc is playing, press the **REPEAT DISC** button until the "Off" indicator displays on the screen.

Off

You can play a single track or a whole disc repeatedly. 

Repeating a single track

You can play the same track repeatedly.

1. While the disc is playing, press the **REPEAT DISC** button until the "Repeat Single" indicator displays on the screen. The current track is played repeatedly.

Repeat Single

Repeating a whole disc

2. While the disc is playing, press the **REPEAT DISC** button until the "Repeat All" indicator displays on the screen. The whole disc is played repeatedly.

Repeat All

To resume normal playback

3. Press the **REPEAT DISC** button until the "Off" indicator displays on the screen.

Off

Repeating a specific section

You can play a specific section repeatedly.

1. While the disc is playing, press the **REPEAT A-B** button at the beginning of the section ((Rep A-) is displayed) you want to play repeatedly.
2. Press the **REPEAT A-B** button again at the end of the section ((Rep A-B) is displayed).
3. The Unit will immediately begin replaying your selection.

Rep A-

Rep A-B

To resume normal playback

4. While the disc is playing, press the **REPEAT A-B** button until the "Off" indicator displays on the screen.

Off

Notes:

- A-B repeat can only be used within the same title. If the start and end of the section to be repeated are in different titles, A-B repeat is cancelled.
- The A-B repeat function does not operate in scenes where different camera angles are recorded.

PLAYING MP3 AND PICTURE FILE DISC

This unit can play MP3 and Picture files recorded on CD-R and CD-RW discs.

Playing a MP3/Picture file disc

1. Slide the **OPEN** switch to open the disc door A/B.
2. Hold a MP3 files/Picture file disc by its sides and carefully fit onto the central support of compartment with the label side facing forward you until you hear a “click”.
3. Push the door to close.
4. The unit will take a short while to load the disc but will begin automatic playback. The MP3 files or Picture files will begin to play one by one.

Press the ▲, ▼, ◀ or ▶ **CURSOR** button to view and select the files you want to listen to. Then press **ENTER** button to confirm and this selected file will be played.

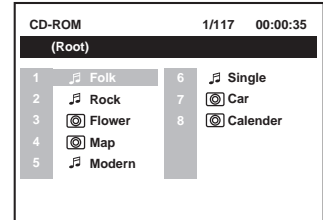

Notes:

- You can press the **II PAUSE** button to interrupt playback, and press the **▶ PLAY** button to resume playback.
- You can also use **GOTO** function or use the numbered buttons to enter the number to quickly select any image.
- Press the **ANGLE** button on the remote control to rotate the picture orientation by 90°.

Playable files:

The ability of this unit to read MP3 discs is dependent on the following:

- The Bit Rate must be within 64 - 256 kbps.
- The total number of files on the disc should not exceed 254.
- The maximum number of directories should not exceed 32.
- The maximum depth level of directories should not exceed 4.
- File names should be named using 7 or fewer letters and/or numbers, and must incorporate the “MP3” file extension. EXAMPLE: *****.MP3 where each * is a letter or number.
- Use only letters and / or numbers in file names. If you use special characters, the file and/or folder names may not be displayed correctly on the on-screen display.
- When recording on CD-R discs, use 74-minute (650MB) discs.
- The CD-R or CD-RW discs should be “finalized” in computer by “single session format”.
- See your CD/MP3 creation software for details.

CUSTOMIZING THE FUNCTION SETTINGS

LANGUAGE setting

1. Press the **SETUP** button in stop mode.
2. Use **▲** or **▼** button to one language, then press the **ENTER** button. The screen will change to your selected language wordings immediately.
3. To exit the SETUP MENU and return to the normal screen, press the **RETURN** button.

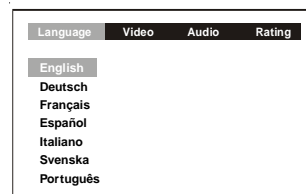

VIDEO setting

1. Press the **SETUP** button in stop mode.
2. Use **◀** or **▶** button to select **Video**, then press the **ENTER** button.
3. Use **▲** or **▼** button to select the options (**TV Shape**, **Brightness** or **Edges**) to be adjusted by press **▲** or **▼** button, then press the **ENTER** button. (The screen will change to your desired setting).
4. Repeats step 2 and 3 above to adjust other options.
5. To exit the FUNCTION SETUP MENU and return to the normal screen, press the **RETURN** button.

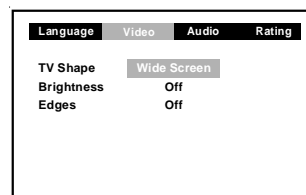

Pan Scan

- When wide-screen video is played, this mode clips the right and left sides of the image so that it can be viewed on a conventional screen.
- Some wide-screen DVDs that do not permit Pan Scan mode playback are automatically played in letterbox mode (black bands top and bottom).

Cut off when a wide screen video image is played.

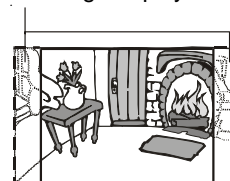

Pan Scan

Letter Box

- When wide-screen video is played in this mode on a conventional screen, black bands appear at the top and bottom of the screen.



Letter Box

Wide Screen

- This is the correct mode for playing wide-screen videos on a wide-screen.



Wide Screen

Notes:

- The displayable picture size is preset on the DVD disc. Therefore the playback picture of some DVD discs may not conform to the picture size you select.
- When you play DVD discs recorded in the 4:3 aspect ratio, the playback picture will always appears in the 4:3 aspect ratio regardless of the TV shape setting.

CUSTOMIZING THE FUNCTION SETTINGS

AUDIO setting

1. Press the **SETUP** button in stop mode.
2. Use ◀ or ▶ button to select **Audio**, press the **ENTER** button repeatedly to select Digital Out type.
3. To exit the FUNCTION SETUP MENU and return to the normal screen, press the **RETURN** button.

Raw: Use this setting when the unit is connected to an external Dolby Digital decoder.

PCM: Use this setting when the unit is connected to an external surround decoder or stereo.

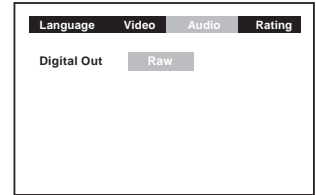

RATING

DVD discs equipped with a password function and are rated according to their content. The contents allowed by parental lock level and the way a DVD disc is controlled may vary from disc to disc. For example, if the disc allowed, you could lock-out violent scenes unsuitable for children or you could lock out playback of the disc altogether.

1. Press the **SETUP** button in stop mode.
2. Use ◀ or ▶ button to select **Rating**, press the **ENTER** button.
3. Use ▲ or ▼ button to select Parental lock and then press the **ENTER** button repeatedly to set the parental lock level.
4. Use ▲ or ▼ button to shift and select Password, enter your 4-digit security code and then press the **ENTER** button.

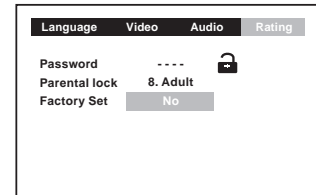

If you make a mistake before pressing the ENTER button, enter your 4-digit security code again.

You cannot play DVD discs rated higher than the level you selected unless you cancel the parental lock function.

The parental lock levels are equivalent to the following ratings.

Level 1 : Kid Safe	Level 5 : PG-R
Level 2 : G	Level 6 : R
Level 3 : PG	Level 7 : NC-17
Level 4 : PG-13	Level 8 : Adult

Note:

It takes 3-5 seconds to reset the unit to the factory default.

If you forget the password, you can erase your current password by pressing number button 8 on the remote four times, then press the ENTER button to confirm the setting (PASSWORD: 8 8 8 8).

 Indicates Parental lock is NOT active.

 The Parental lock is active.

LANGUAGE CODE LIST FOR DISC LANGUAGE

Code	Language Name	Code	Language Name	Code	Language Name	Code	Language Name
AA	Afar	FY	Frisian	MG	Malagasy	SL	Slovenian
AB	Abkhazian	GA	Irish	MI	Maori	SM	Samoan
AF	Afrikaans	GB	Scots Gaelic	MK	Macedonian	SN	Shona
AM	Ameharic	GL	Galician	ML	Malayalam	SO	Somali
AR	Arabic	GN	Guarani	MN	Mongolian	SQ	Albanian
AS	Assamese	GU	Gujarati	MO	Moldavian	SR	Serbian
AY	Aymara	HA	Hausa	MR	Marathi	SS	Siswat
AZ	Azerbaijani	HI	Hindi	MS	Malay	ST	Sesotho
BA	Bashkir	HR	Croatian	MT	Maltese	SU	Sundanese
BE	Byelorussian	HU	Hungarian	MY	Burmese	SV	Swedish
BG	Bulgarian	HY	Armenian	NA	Nauru	SW	Swahili
BH	Bihari	IA	Interlingua	NE	Nepali	TA	Tamil
BI	Bislama	IE	Interlingue	NL	Dutch	TE	Telugu
BN	Bengali	IK	Inupiak	NO	Norwegian	TG	Tajik
	Bangla	IN	Indonesian	OC	Occitan	TH	Thai
BO	Tibetan	IS	Icelandic	OM	(Afan) Oromo	TI	Tigrinya
BR	Breton	IT	Italian	OR	Oriya	TK	Turkmen
CA	Catalan	IW	Hebrew	PA	Panjabi	TL	Tagalog
CO	Corsican	JA	Japanese	PL	Polish	TN	Setswana
CS	Czech	JI	Yiddish	PS	Pashto, Pushto	TO	Tonga
CY	Welsh	JW	Javanese	PT	Portuguese	TR	Turish
DA	Danish	KA	Georgian	QU	Quechua	TS	Tsonga
DE	German	KK	Kazakh	RM	Rhaeto- Romance	TT	Tatar
DZ	Bhutani	KL	Greenlandic			TW	Twi
EL	Greek	KM	Cambodian	RN	Kirundi	UK	Ukrainian
EN	English	KN	Kannada	RO	Romanian	UR	Urdu
EO	Esperanto	KO	Korean	RU	Russian	UZ	Uzbek
ES	Spanish	KS	Kashmiri	RW	Kinyarwanda	VI	Vietnamese
ET	Estonian	KU	Kurdish	SA	Sanskrit	VO	Volapük
EU	Basque	KY	Kirghiz	SD	Sindhi	WO	Wolof
FA	Persian	LA	Latin	SG	Sangho	XH	Xhosa
FI	Finnish	LN	Lingala	SH	Serbo- Croatian	YO	Yoruba
FJ	Fiji	LO	Laothian			ZH	Chinese
FO	Faroese	LT	Lithuanian	SI	Singhalese	ZU	Zulu
FR	French	LV	Latvian, Lettish	SK	Slovak		

MAINTENANCE

Cleaning Disc

A defective or soiled disc inserted into the unit can cause sound to drop out during playback.

Handle the disc by holding its inner and outer edges.

- Do NOT touch the surface of the unlabeled side of the disc.
- Do NOT stick paper or tape on the surface.
- Do NOT expose the disc to direct sunlight or excessive heat.
- Clean the disc before playback. Wipe the disc from the center outward with a cleaning cloth.
- NEVER use solvents such as benzine or alcohol to clean the disc.
- Do NOT use irregular shape discs (example : heart shaped, octagonal, etc.). They may cause malfunctions.

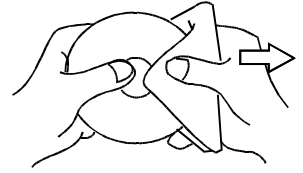

Cleaning the unit

- Be sure to turn the unit off and disconnect the AC adapter before maintaining the unit.
- Wipe the unit with a dry soft cloth. If the surfaces are extremely dirty, wipe clean with a cloth which has been dipped in a weak soap-and-water solution and wrung out thoroughly, then wipe with a dry cloth.
- Never use alcohol, benzine, thinner, cleaning fluid or other chemicals. Do NOT use compressed air to remove dust.

Important Note

Before transporting the unit, take out the disc from the disc compartment.

TROUBLE SHOOTING GUIDE

SYMPTOM	CAUSE (AND REMEDY)
No power.	<ul style="list-style-type: none">• Check that the AC cord and AC adapter or the Car plug adapter are connected.• You did not turn on the unit.
The remote does not function.	<ul style="list-style-type: none">• Remove any obstacles between the remote and the unit.• Use the remote near the unit.• Point the remote at the remote sensor on the unit.• Replace the battery in the remote with new one.
DVD	
No sound or only a very low-level sound is heard.	<ul style="list-style-type: none">• Make sure that you've select DVD mode.• The system is in pause mode. Press the ► PLAY button to return to normal play mode.• Fast forward or fast reverse is performed. Press the ► PLAY button to return to normal play mode.• Make sure that AUDIO / VIDEO output and AV IN input connections are correct.• The DTS DVD disc cannot be decoded to have speaker output.• This unit is too hot, shut off the unit for 30 minutes to cool down.
No picture.	<ul style="list-style-type: none">• The region number of the disc doesn't match the region number of this unit. 
The picture is not clear.	<ul style="list-style-type: none">• Clean the disc.• The disc is scratched.
Severe hum or noise is heard.	<ul style="list-style-type: none">• The plugs and jacks are dirty. Wipe them with a cloth slightly moistened with alcohol.• Clean the disc.
The disc does not play.	<ul style="list-style-type: none">• There is no disc inside ("No Disc" appears on the screen).• Insert the disc correctly with the playback side facing forward.• Clean the disc.• A non-NTSC disc has been inserted. The unit and disc region number are incompatible.• Condensation may have formed inside the unit due to a sudden change in temperature. Wait about an hour for it to clear and try again.

NOTICE: Kawasaki is trademark licensed by Kawasaki Motors Corp., U.S.A. However, this product is neither manufactured nor distributed by Kawasaki Motors Corp., USA. Consumer inquiries should be directed to Alco Electronics at 1-800-252-6123.